

# Ancerre

DESIGNS

VTS-ELIZABETH-48

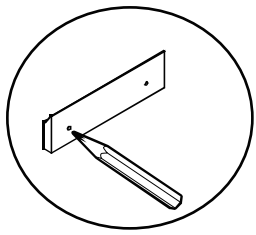

A

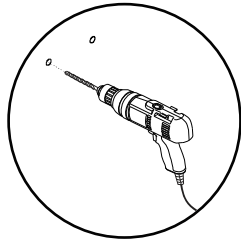

B

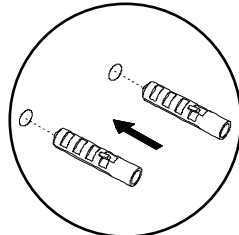

C

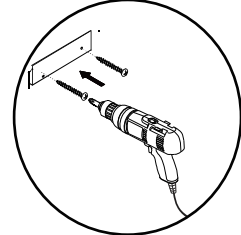

D

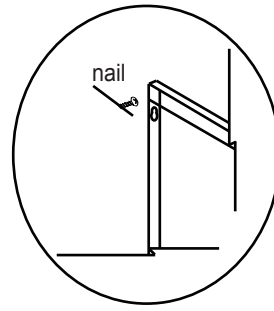

E

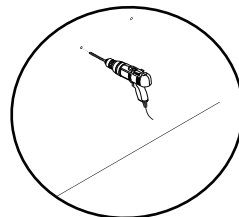

F

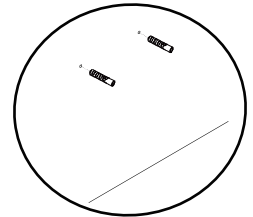

G\*

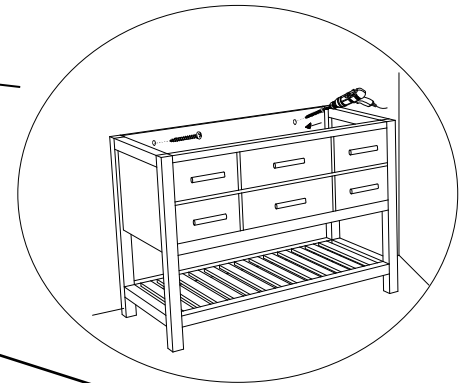

H

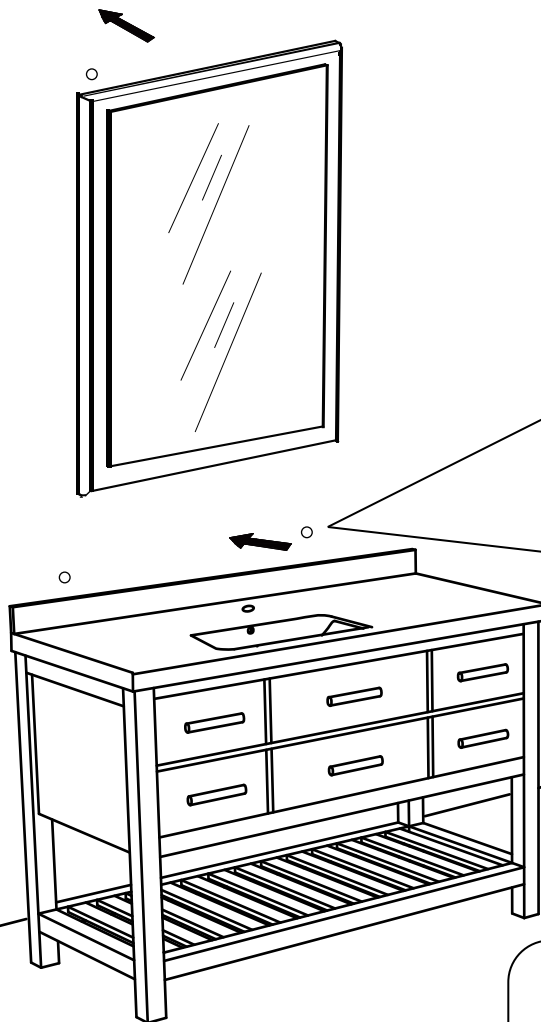

Adjustable leg leveler.  
Adjust for level.

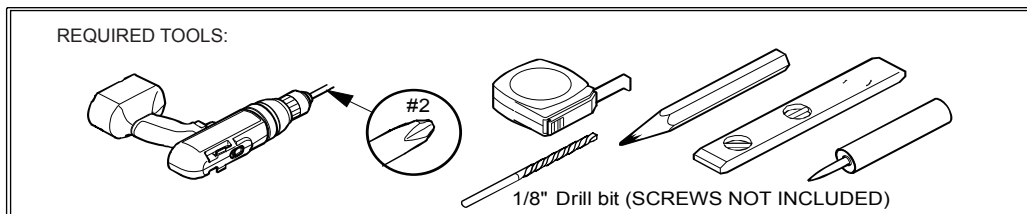

\*SECURE SCREW TO STUDS WHEN POSSIBLE

# Ancerre

D E S I G N S

VTS-ELIZABETH-60

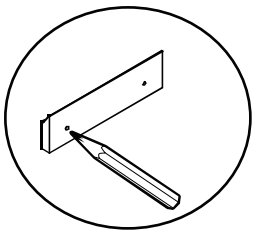

A

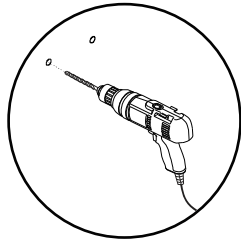

B

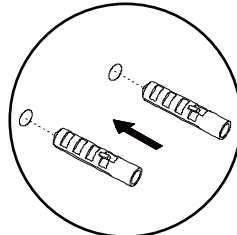

C

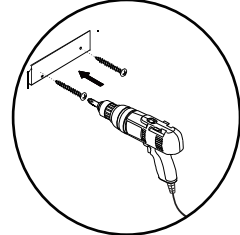

D

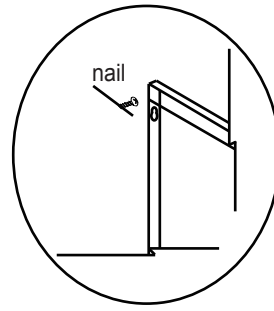

E

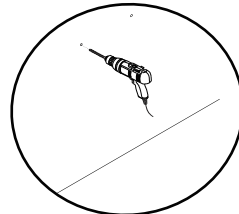

F

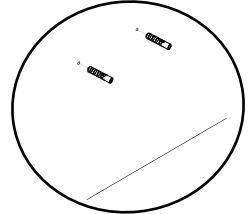

G\*

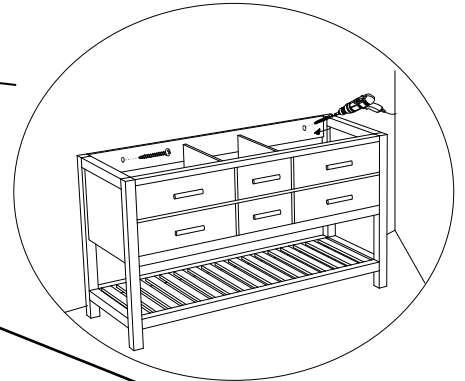
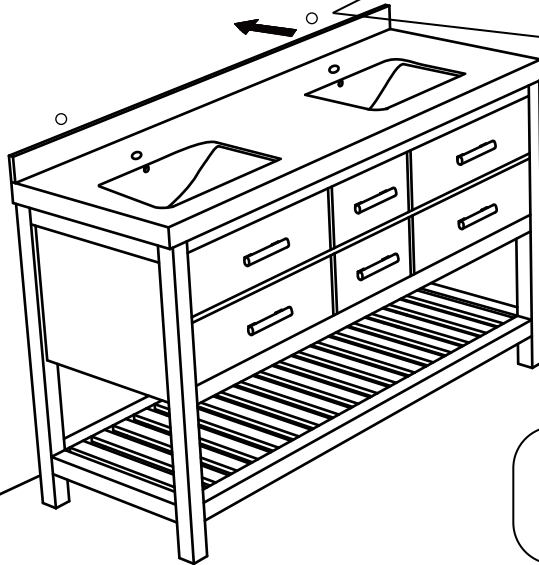
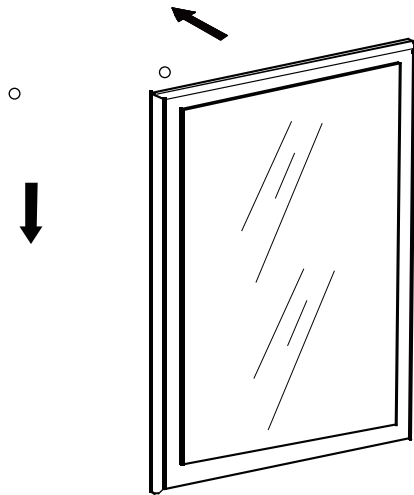

H

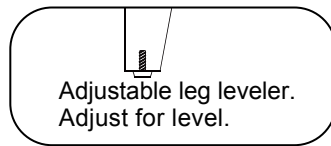

REQUIRED TOOLS:

1/8" Drill bit (SCREWS NOT INCLUDED)

\*SECURE SCREW TO STUDS WHEN POSSIBLE

# Ancerre

D E S I G N S

VTS-ELIZABETH-72

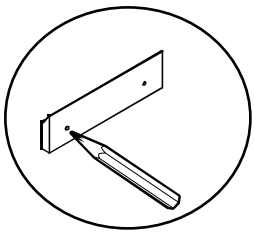

A

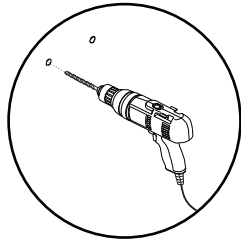

B

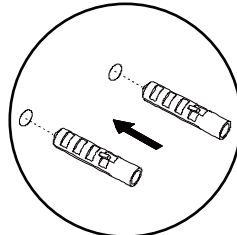

C

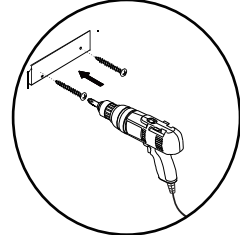

D

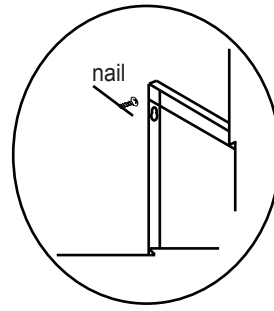

E

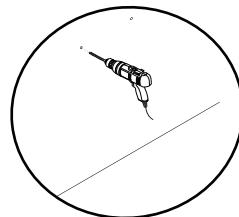

F

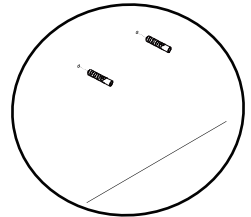

G\*

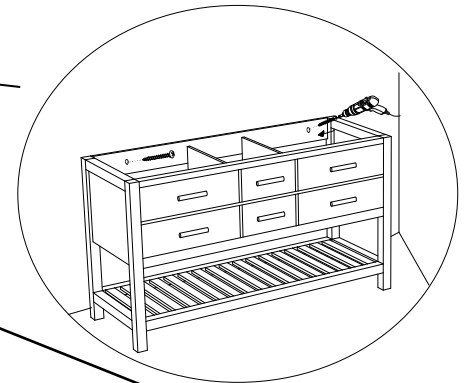
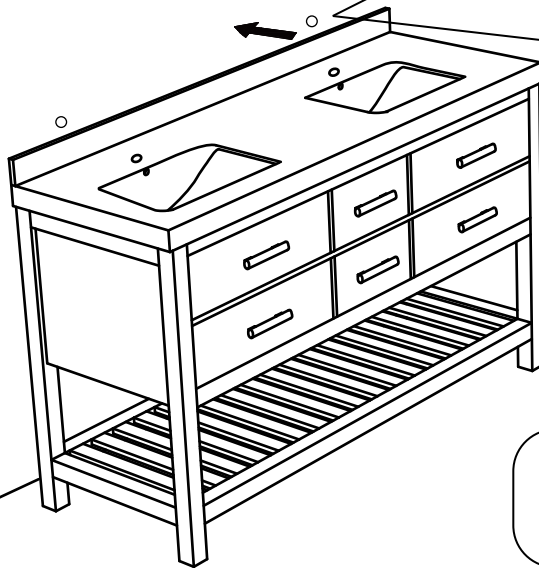
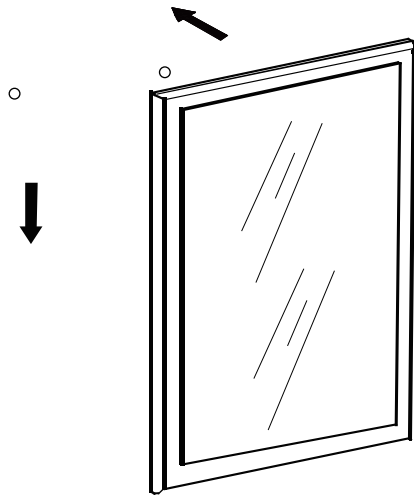

H

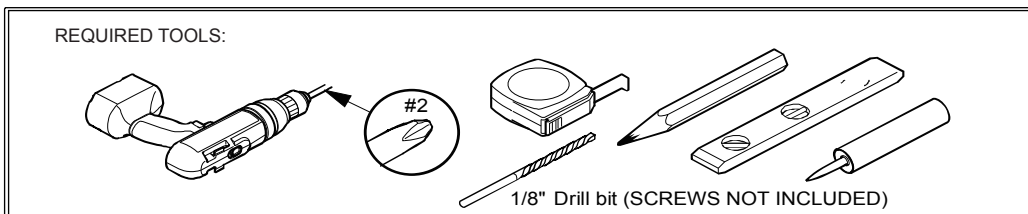
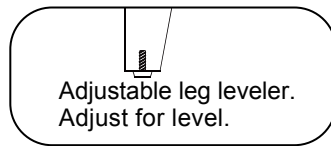

\*SECURE SCREW TO STUDS WHEN POSSIBLE